

**oerlikon**

# **Making sustainable aerospace innovations fly**

With high-end surface solutions, advanced materials, additive manufacturing and turbine components



**Aerospace**



# Oerlikon – a global, high-tech engineering group with unique competencies

We are a market leader in advanced materials, surface engineering and polymer processing. Our solutions encompass materials, coating equipment, coating services, and the engineering of entire plants. We build our business on unique technology competencies, the widest global reach and trusted customer relations in highly demanding industries such as aerospace, automotive, energy, tooling and textiles.

Every day, we develop novel materials, new surface technologies, new applications, components and textile manufacturing solutions to empower our customers to create and innovate better products.

Every major aero engine manufacturer trusts our technologies to boost performance, improve safety and fuel efficiency and reduce emissions.

## Our solutions for enhanced aircraft components



**1 Actuation systems**

**2 Cockpit instrumentation**

**3 Tools for structural development**

**4 Air conditioning systems**

**5 Interior decor**

**6 Landing gears and airframe components**

**7 Tools for chassis processing**

# Capability ready for ramp up of production

Oerlikon is your best position with resources and capacity in place to meet the supply demands of the Aerospace industry today and tomorrow. As one stop shop and dedicated program manager to simplify the supply chain for Aerospace applications with the most comprehensive offering of:

- Advanced materials for surface engineering, additive manufacturing and other processes
- Surface engineering technologies and services including thin film, thermal spray and other solutions
- Heat treatment solutions such as hardening, vacuum and HIP furnace
- Conventional and non-conventional machining and manufacturing of turbine components
- Additive manufacturing solutions from application engineering, manufacturing to post processing



**8 Fan blades, LPC and HPC blades, vanes, shrouds and rotor seals**

**9 Turbine hot section components such as combustors, bearings and bushings, HPT blades and vanes**

**10 Engine pylons, fuel pumps**

**11 Machining of lightweight materials**

# Making aerospace more sustainable, powerful and efficient

## Industry challenges

- Improve engine performance and efficiency to reduce fuel consumption and meet CO<sub>2</sub> and NO<sub>x</sub> emission standards
- Enable hot engine components to operate at higher temperatures to improve efficiency and extend lifespan
- Meet demanding requirements for next-generation aircraft landing gears and air frame components, while replacing noxious hard chromium processes
- Reduce weight and production cost of complex engine parts, structural components and replacement parts

## Solutions

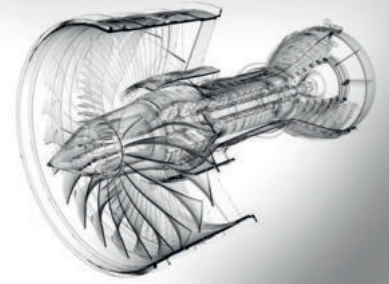

### Improve gas path efficiency

Engines sealed with abradable coatings achieve improved performance, increased safety, decreased fuel consumption and reduced CO<sub>2</sub> and NO<sub>x</sub> emissions.



### Faster instrument recognition

Attractive wear protection color coatings with long life and high performance for interior appliances.



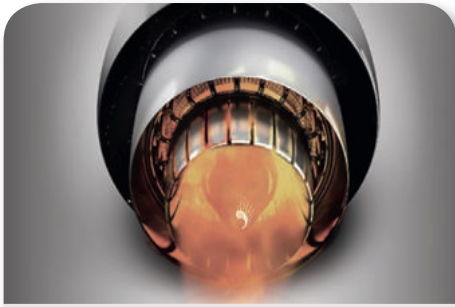

**Resist high temperatures**

Thermal barrier coatings used in combustor and turbine sections of engines protect underlying materials from temperatures that these substrates could otherwise not tolerate.



**Ensure safe landings**

Landing gears coated with our high-velocity oxygen fuel thermal spray technology achieve superior performance and safety. These coatings replace the noxious hard chromium process.

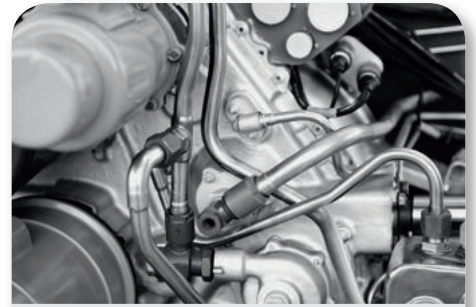

**Lower costs with increased lifetime**

Functional PVD coatings significantly improve the performance and durability of precision components and tools. Component service life is increased by using our coatings that reduce friction and protect against wear.

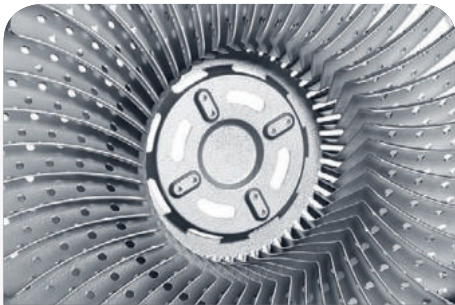

**Break performance barriers**

The design freedom of additive manufacturing technology enables optimized performance of aerospace parts with reduced weight and part consolidation.

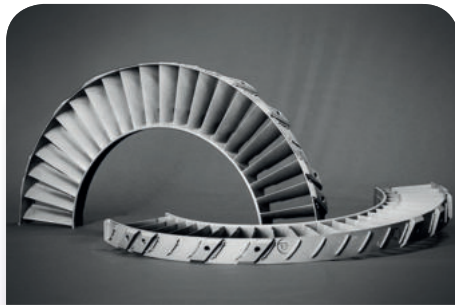

**Top-notch manufacturing**

To improve aircraft engine efficiency, we produce sheet metal and machined components such as inserts and compressor vane assemblies.



**Lower costs with increased lifetime**

Functional wear coatings significantly improve the performance and durability of bearings and bushings within the engine offering longer on-wing performance via reduced friction and protecting against wear.



# Oerlikon Balzers surface solutions

## Thin film solutions for aerospace components and cutting tools

### Protect valuable components and cutting tools from all types of wear

We are one of the world's leading suppliers of thin-film technologies that significantly improve the performance and durability of precision components and tools. Protected with our BALINIT® coatings, the lightweight components used in the aerospace industry permit greater loads, meet closer tolerances, and lower the cost of maintenance.

BALINIT®, BALIQ® and BALDIA® coated cutting tools meet the highest expectations in machining high-end aerospace materials like titanium and nickel alloys as well as CFRP (carbon fiber reinforced plastics).

Thanks to our network of Nadcap-certified customer centers in all relevant industry locations around the globe, our aerospace customers benefit from high-end coating services wherever they are.



## Coatings for cutting tools to machine aerospace components

Cutting tools have to resist wear under serious conditions, from high cutting temperatures to heavy loads causing friction and difficulties in removing chips.

We supply state-of-the-art BALINIT®, BALIQ® and BALDIA® coatings that fulfil those requirements — and are based on the environmentally friendly and future-oriented PVD and PACVD coating technologies.

### Advantages of coated tools:

- Longer tool life
- Retention of tolerances and surface quality
- Increase of productivity due to higher cutting speed and feed
- Possibility of reduced lubrication and dry machining
- Enable machining within smaller tolerances
- Excellent wear resistance of the tools



## BALINIT TURBINE PRO – a compressor erosion and hot corrosion protection coating

BALINIT® TURBINE PRO, the anti-erosion coating for compressor blades, offers outstanding protection from solid particle erosion (SPE) and liquid droplet erosion (LDE) without affecting your component's fatigue life.

BALINIT® TURBINE PRO is 40 times more erosion resistant than steel and 5 times more erosion resistant than other PVD coating solutions.

## BALORA PVD MCrAlY – for high temperature applications

In order to improve the efficiency level of gas turbines, the operating temperatures are often increased to 1.200 °C and beyond. The BALORA® PVD MCrAlY coating meets these extraordinary requirements. It exhibits an excellent substrate adhesion, and can be applied up to a thickness of 100 micrometers without porosity.

Most importantly the MCrAlY composition in combination with the high density can be tailored to provide the optimal barrier against oxidation.

	BALINIT TURBINE PRO	BALORA PVD MCrAlY
Coating material	MeAlN	NiCrAlY (Ni, Ni/Co, Co)
Coating hardness $H_{IT}$	$32 \pm 2$ GPa / $4641 \pm 300$ ksi	7 – 11 GPa
Typical coating thickness ( $\mu\text{m}$ )	5 – 25	0.1 to > 100
Friction against steel, dry running	~ 0.5	~ 0.5
Coating temperature	< 500 °C / < 932 °F	400 – 500 °C / 752 – 932 °F
Max. service temperature	< 750 °C / < 1382 °F	Appr. 1,200 °C / appr. 2,192 °F
Color	Violet-grey	Grey



### Coatings for aircraft interior design

Oerlikon Balzers offers attractive wear protection color coatings with long life and high performance for interior appliances. Cabin fixtures can be coated with BALSTONE™ coatings offering a wide range of colors to match your aircraft interiors.

# Oerlikon Metco surface and material solutions

## Maximum protection to optimize performance, reliability and durability

Today, almost all turbine-powered aircrafts have our solutions on board, and we have more OEM approvals than any other coating material supplier. Our next-generation solutions are designed to protect expensive aerospace

components from wear, corrosion, oxidation, thermal attack and more. Even as operating temperatures continue to rise for aircraft power plants, our solutions will be there to keep them operating efficiently and safely.

**A trusted partner today that's ready to protect and optimize the performance of tomorrow's aircraft.**

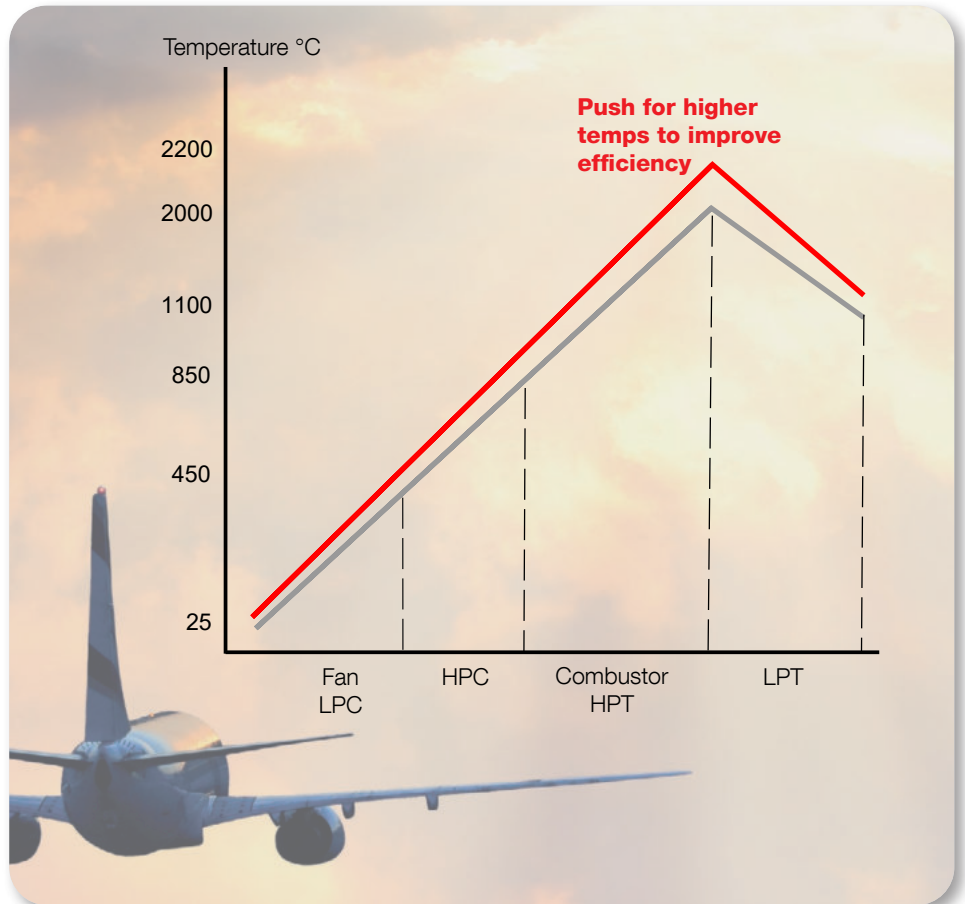

### High-tech protection

Our advanced EBC coating solutions protect ceramic matrix composite components from the harsh service conditions of tomorrow's advanced engines.

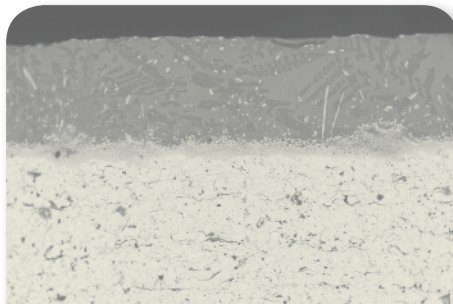

### Innovative solutions to resist attack

New materials continually being developed to arrest coating degradation caused by CMAS; allowing engines to operate longer in harsh environments.

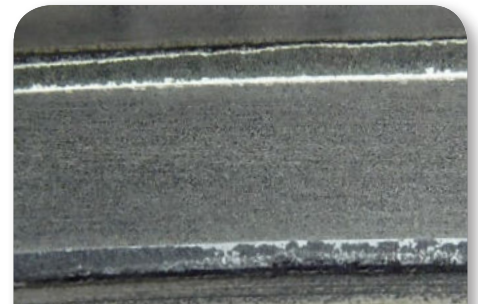

### Corrosion-Resistant Compressor Abradable

Coatings for gas turbine compressors with improved corrosion resistance that reduces maintenance and operating costs.



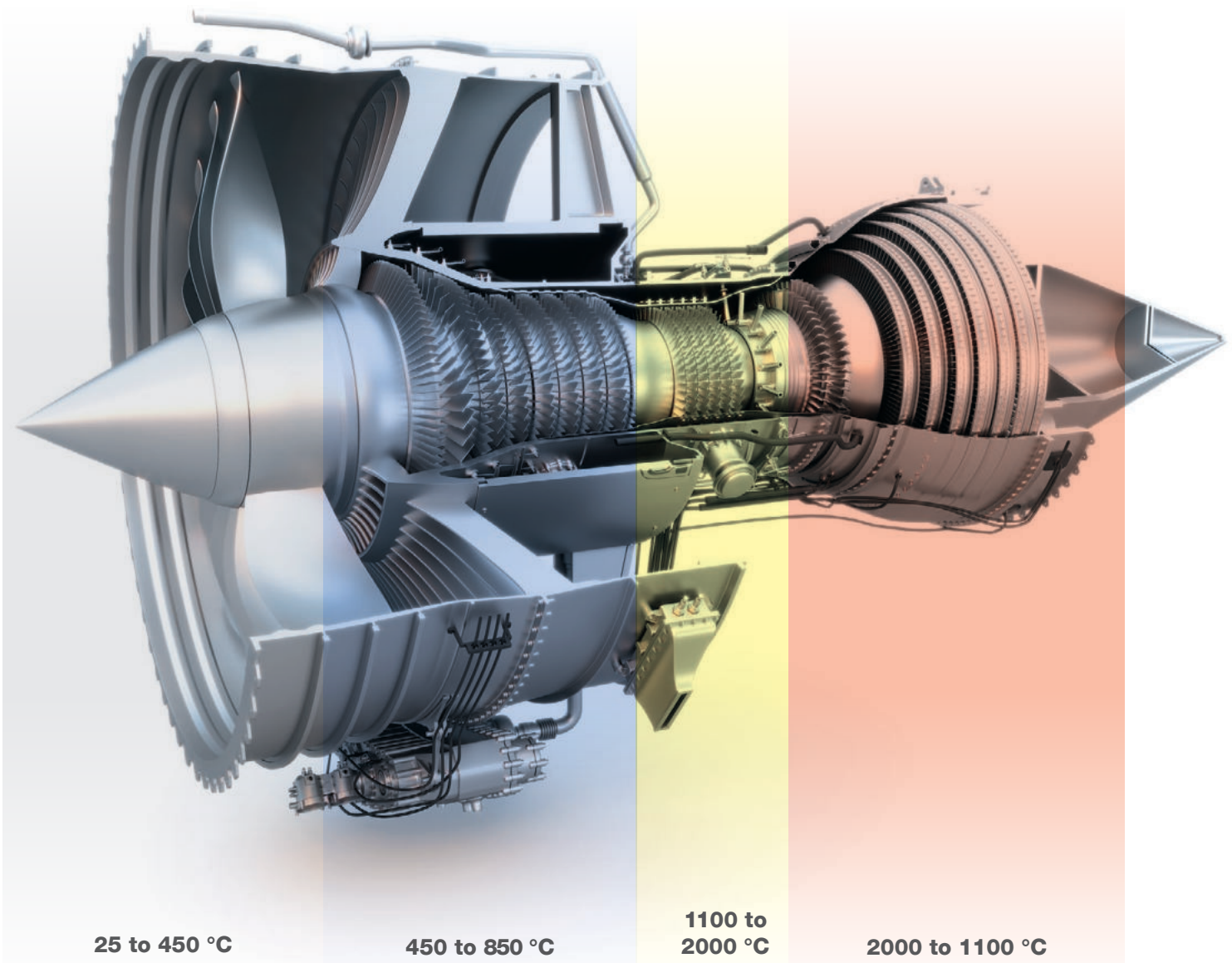

**Operate at peak efficiency**

As the leader in abradable coatings, we continually evolve our solutions to more effectively improve efficiency in all parts of the engine.

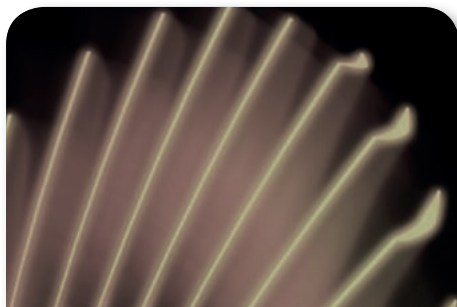

**Quell high-temperature corrosion**

Advanced corrosion coatings protect HPC, HPT and LPT blades from oxidation and corrosion.

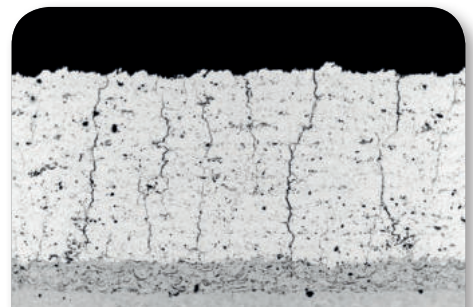

**Novel solutions for hotter engines**

New compositions for advanced-structured TBCs and efficient, novel approaches to applying them allow engines to operate at higher temperature over long service intervals.

## Technology and services designed to provide the best performance and efficiency

We ensure our customers get the best solution by using all of our expertise and know-how during every step of the process. Our goal is to provide our customers with a solution that not only meets their exact technical requirements, but is also as efficient and cost-effective as possible.



### Material generation >

Design and selection of **materials** to address the customer's application requirements

#### Materials for:

- Power plants
- Landing gears
- Airframes

### Application technology >

Tailored **state-of-the-art equipment** to efficiently apply a superior surface solution

#### Equipment for:

- Thermal spray

### Process optimization >

**Optimized materials and processes** yield a surface solution of the highest performance

#### Coating solution centers

marry materials, processes and equipment for optimal performance

### Surface solution

**Advanced cost effective** surface solutions for today's and tomorrow's critical aerospace components

#### Coating centers

deploy solutions using:

- Thermal spray and other processes
- PS-PVD
- Pre- and post-coat machining and inspection

## One stop solution provider for hot and cold section turbine engine components

- Production cell concepts servicing high level of delivery performance
- Cross functional work approach with customers for new part introduction
- Supplier to all major aero engine programs
- High-end machining and manufacturing processes with a high level of automation

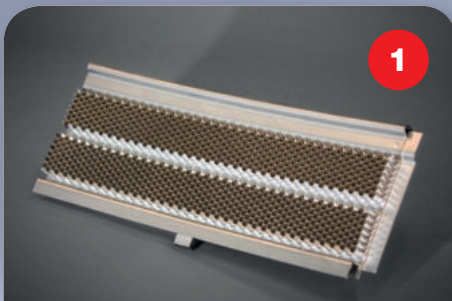
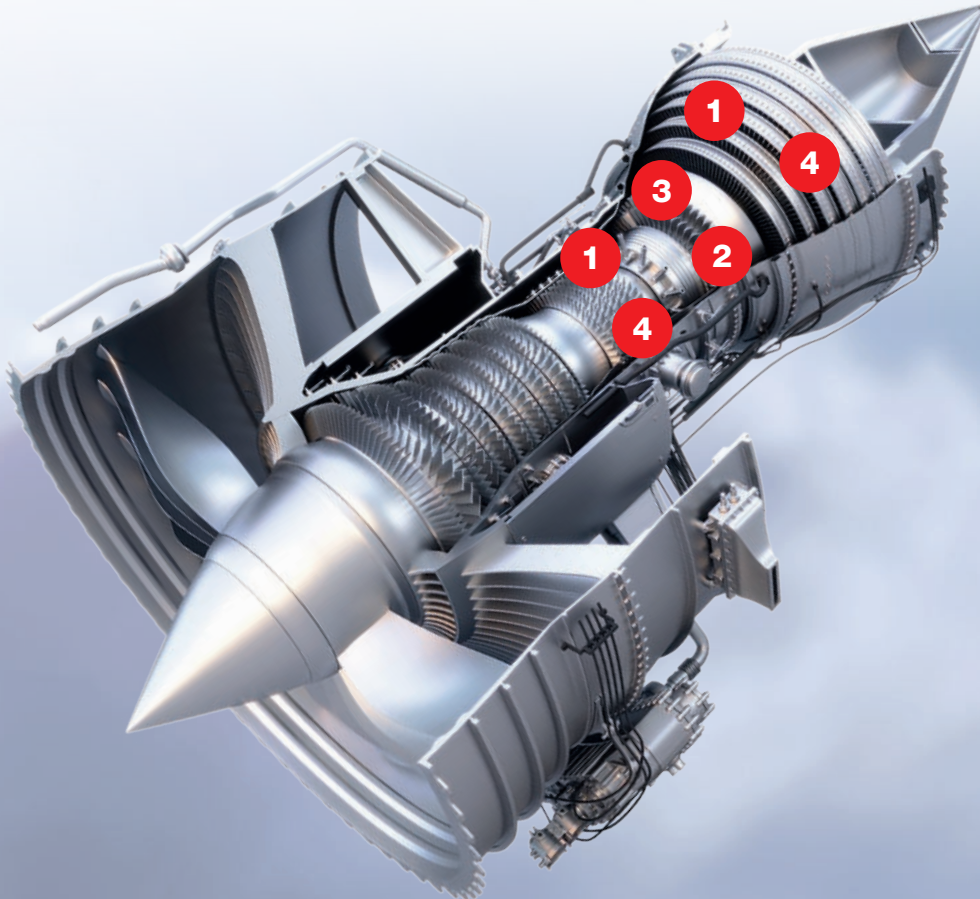

### Turbine seals

Provide sealing between the engine housing and the rotating blades to maintain gas-path compression. The seals are manufactured from sheet metal or forgings and castings. Customer-specific, shaped honeycomb is applied onto the seal to ensure the sealing function of the component.



### Turbine components cooling hole drilling

Cooling holes (transversal / longitudinal) prevent the deformation of rotating airfoils from the intense heat of the engine's hot section. These cooling holes are processed through EDM processes and inspected by airflow testing.



### Vane inserts

Sheet metal inserts provide accurate impingement cooling on the inside of the hollow airfoils. Blanks are pressed into the correct shape. The seam is then securely fastened to ensure closure of the insert.

# Oerlikon AM additive manufacturing solutions

## Making aircraft safer, lighter and more efficient

Typical aerospace applications are complex engine parts, structural components and replacement parts. Additive manufacturing enables the production of such parts at a lower weight and significantly reduced life-cycle costs.

For aircraft applications like brackets, ducting, or seat belt buckles, additive manufacturing can be leveraged for weight and flow optimization, sound reduction, and part count reduction.

- 1 Aircraft brackets**
- 2 Seat belt buckles**
- 3 Ducting**
- 4 Impact protection**
- 5 Compressor vanes**
- 6 System integration**
- 7 Heat exchangers**
- 8 Ducting**
- 9 Diffusers**
- 10 Acoustic attenuation**
- 11 Vents**
- 12 Windshield defogger duct nozzles**
- 13 Brackets**
- 14 Housing and enclosures**
- 15 Drain fairings**
- 16 Payload enclosures**
- 17 Camera mounts and gimbals**
- 18 NACA ducts**
- 19 Fuselage structure**
- 20 Fuel tanks**
- 21 Shrouds and closeouts**
- 22 Wing structure**
- 23 Battery compartment**
- 24 Oil tanks**
- 25 Ailerons and flaps**

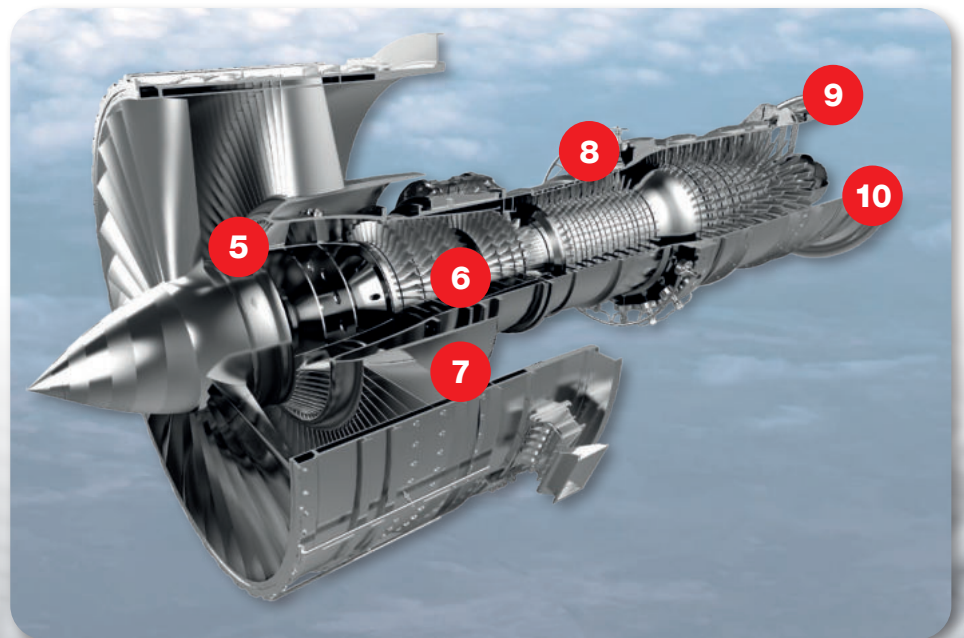

Additive manufacturing can also have a significant impact on aero engines by integrating components for reduced part counts and mass for compressor vanes, diffusers, acoustic attenuation, heat exchangers, and more.

From brackets to instrument housings in helicopters, and from fuselage structures to battery compartments in UAVs, additive manufacturing makes a difference in a variety of rotorcraft and defense applications.

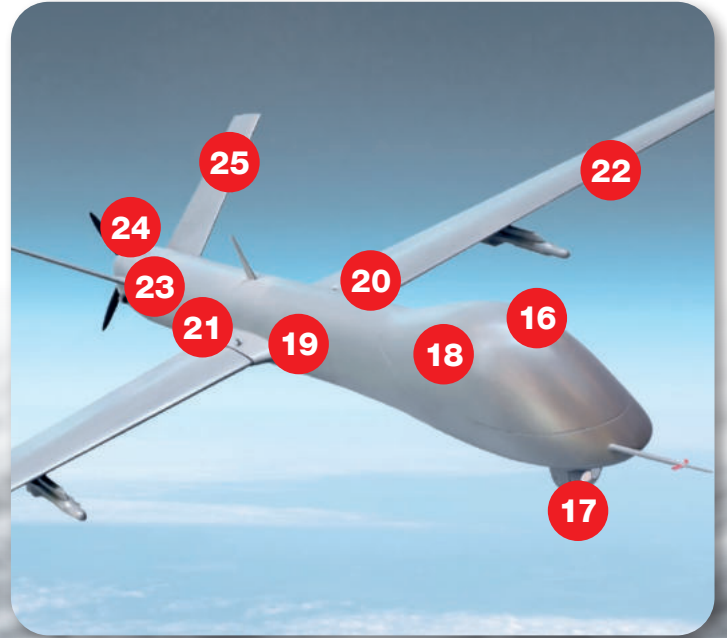

# Your global AM product development and manufacturing partner with a strong background in

## Why choose us as your partner?

We provide:

- AS9100, ITAR registered, full spectrum capabilities for quality control and traceability, and affordability, with powder atomization, R&D and production all delivered in-house
- Aerospace-specific application engineering with focus on areas like generative design / weight reduction, highly customized parts, weld elimination, reverse engineering and replacement of obsolete parts. Support for material and component qualification
- Collaboration opportunities: Material development, data set / design allowables generation, R&D, application engineering, series production and prototypes



## Engineering



Atomization  
& Materials



Process- &  
applications  
engineering



Manufacturing  
engineering



Powder management



Production

**Additive**

**aerospace and defense**

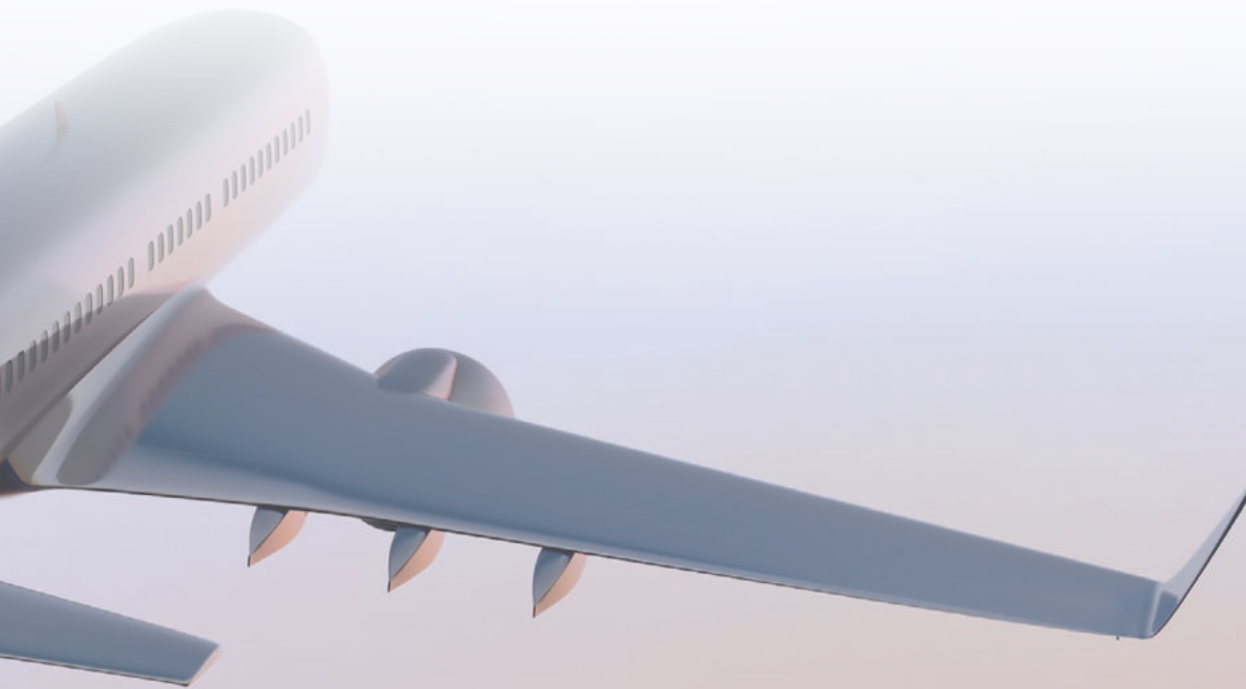

**Post processing**



Heat treatment



CNC



Surface treatment



Quality assurance & certification

**manufacturing**

# Count on a powerful network of over 170 sites in 38 countries



**ACCREDITED**

- Debrecen / Hungary (Metco)
- Ferrières-en-Brie / France (Balzers)
- Ft. Saskatchewan / Canada (Metco)
- Guelph / Canada (Balzers)
- Lomm / Netherlands (Metco)
- Milton Keynes / UK (Balzers)
- Niedercorn / Luxembourg (Balzers)
- Plymouth, MI / USA (Metco)
- Troy, MI / USA (Metco)
- Salzgitter / Germany (Metco)
- Westbury, NY / USA (Metco)

## EN/AS/JISQ 9100 certified

- Barchfeld / Germany (Metco)  
also ISO 17025
- Barleben / Germany (AM)
- Charlotte, NC / USA (AM)
- Debrecen / Hungary (Metco, Eldim)
- Elgin, IL / USA (Balzers)
- Ferrières-en-Brie / France (Balzers)
- Ft. Saskatchewan / Canada (Metco)
- Lomm / Netherlands (Metco, Eldim)
- Milton Keynes / UK (Balzers)
- Plymouth, MI / USA (Metco)
- Salzgitter / Germany (Metco)
- Troy, MI / USA (Metco)
- Stockport / UK (Metco, Neomet)
- Westbury, NY / USA (Metco)
- Wohlen / Switzerland (Metco)

## Contact us now!

### Technology brand headquarters

#### Oerlikon Balzers

Iramali 18  
LI-9496 Balzers  
Liechtenstein  
T +423 388 7500

[www.oerlikon.com/balzers](http://www.oerlikon.com/balzers)

#### Oerlikon Metco

Churerstrasse 120  
CH-8808 Pfäffikon  
Switzerland  
T +41 58 360 96 96

[www.oerlikon.com/metco](http://www.oerlikon.com/metco)

#### Oerlikon AM

Kapellenstraße 12  
D-85622 Feldkirchen  
Germany  
T +49 89 203 015 015

[www.oerlikon.com/am](http://www.oerlikon.com/am)

**oerlikon**  
balzers

**oerlikon**  
metco

**oerlikon**  
am