

# Electric Arc Wire Spray Solutions

June 2022



# Introduction

## A simple, fast and economical process

**The simplicity of this thermal spray process, usually packaged as a complete spray unit, makes electric arc wire spray an excellent choice for in-shop or on-site work.**

Among the first of the thermal spray processes to be invented, electric arc wire spray holds its own as the favored process for many coating applications. Using only the power of electricity, electric arc wire spray requires no process gases other than atomizing air. As a result, coatings are characteristically clean and often more machinable than those produced using other thermal spray processes. With the lowest number of input parameters of any thermal spray process, electric arc wire systems are simple to operate and maintain, yet produce very reliable and robust coating results.

With our full range of electric arc spray equipment and wire materials for general and specialized applications, combined with our extensive portfolio of support services and decades of experience, you can see why so many customers choose Oerlikon Metco as their supplier of choice.

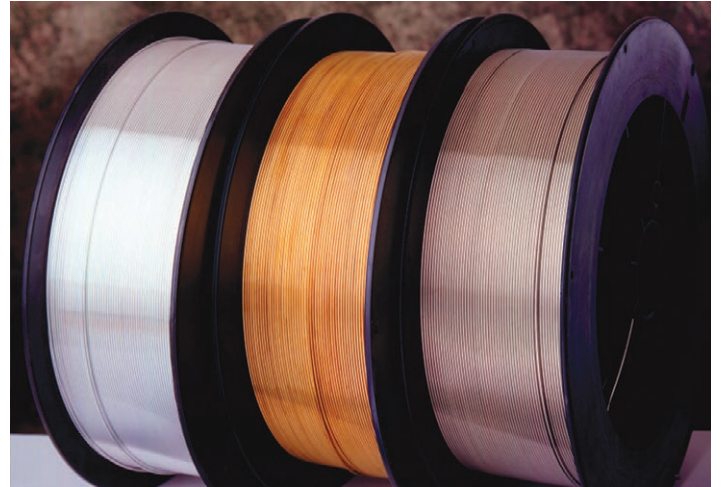

**Optimum Materials...**



**Innovative Technology...**

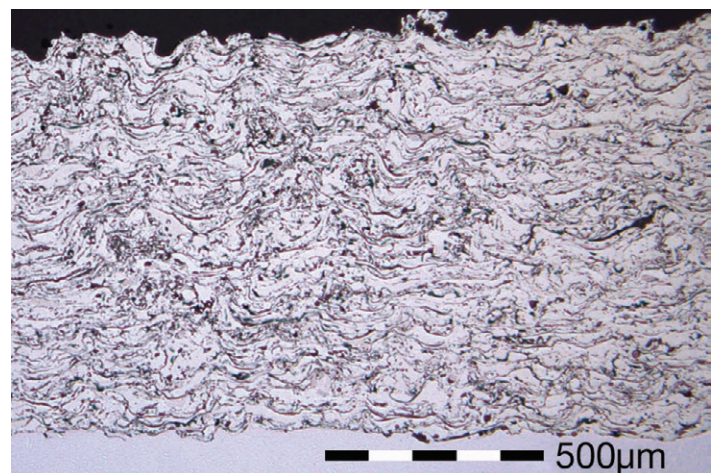

**Perfect Coatings...**

It's the performance and value package you've been looking for!

# Applications

## In shop or on site, Electric Arc Wire Spray delivers

Rough or smooth...thin or thick...on large structures or small components, electric arc wire spray delivers outstanding coatings. Whatever your electric arc coating application, Oerlikon Metco has a perfectly tailored solution that is simple to use and provides highly reliable, controlled surface results.

Our surface engineering experts can show you how electric arc spray can:

- Manufacture components that exhibit specific surface characteristics.
- Use less costly substrate materials for components, yet maintain high performance surface properties.
- Improve component service life.
- Repair existing components to like-new or better than new condition.
- Salvage mismachined components.
- Provide a high-performance bond coat in a coating system.

Surface Functionality Achieved with Electric Arc Wire Spray

- Resistance to many corrosive environments,
- Galvanically active and sacrificial coatings
- Resistance to wear, erosion and cavitation
- High temperature, oxidation resistance
- Prevention of biofouling
- Dimensional restoration
- Controlled surface profiles or textured surfaces
- Gripping and anti-skid surfaces
- Low friction surfaces
- Decorative and cosmetic treatments
- Human or machine-readable surface markings
- Optically reflective surfaces
- Electrical conductivity
- RFI and EMI shielding
- Solderable surfaces
- Bond coat for other industrial coatings or paints

Industry	Component/Structure		
Power Generation	Boiler Walls	Fans	Wind Turbine Blade Hubs, Bearings and Towers
Waste Incineration	Boiler Walls	Superheater Tubes	
Electronics	Capacitors and Varistors	High Voltage PCB	Plastic Cases and Covers
	LCD/Plasma Screen Tooling		
Automotive	Heat Exchanger Tubes	Weld Seams	Prototype Textured Mold Linings
	Brake Test Equipment	T-Frame Joints	
Aerospace	Turbine Engine Components	Airframe Composites	Airframe Metallic Components
Oil/Gas/Petrochemical	Pipes, Valves, Pump Housings, Tanks	CUI (Corrosion Under Insulation)	
Pulp/Paper/Printing	Black Liquor Recovery Boilers	Yankee Drier Rolls	Impression Cylinders
Steel/Metal Production	Paper Transport Clamps		
	Roller Bearing Housings	Cold Work Roll Bearing Seats	Slab/Billet/Pipe
Marine	Carbon Electrodes	Tube Weld Seams	
	Steel Components/Structures	Propellers	
General Industry	Various Components	Plastic Production	Prototype Textured Mold Linings
Glass/Optics	Sputter Targets	Glass Components	
Infrastructure	Bridges and Structures	Sacrificial Anodes	Impressed Current Electrodes
	Road Markers	Water Mains	Ozone Arc Tubes
Commercial	Statuary and Building Ornamentation		

# Process

## Harnessing electrical energy to create high utility surfaces

Like all thermal spray processes, the electric arc wire process requires a heat source to melt the coating feedstock; however, it is unique in that it does not employ process gases to generate the heat source. The electric arc wire spray process uses two metallic wires, usually of the same composition, as the coating feedstock. The two wires are electrically charged with opposing polarity and are fed into the arc gun at matched, controlled speeds. When the wires are brought together at the contact point, the opposing charges on the wires create an arc that continuously melts the tips of the wires. Compressed air is used to atomize the now molten material and accelerate it onto a properly prepared workpiece surface to form the coating.

In electric arc wire spray, the weight of coating that can be deposited per unit of time is directly related to the output amperage of the system and the density and melting point of the wire.

Depending on the columnar strength of the wire, 'push', 'pull' or 'push/pull' mechanisms can be used to feed the wire at a constant rate.

The unique operational properties of the electric arc wire process gives it these outstanding features:

- Applies a range of metallic alloys and pure metals for restoration, corrosion coatings and many other purposes
- Wire coating materials are either solid wires or cored (filled) wires, maximizing application potential
- Systems are compact and self-contained
- Excellent portability for on-site coatings
- Relatively cool process allows coatings to be applied to plastics, composites, glass, etc.
- Does not require any process water or gases except compressed air
- High spray rates
- Coatings are easy to machine

- Adjacent surfaces that should not be coated can be easily masked
- Capable of coating some internal geometries
- Very simple to operate and maintain

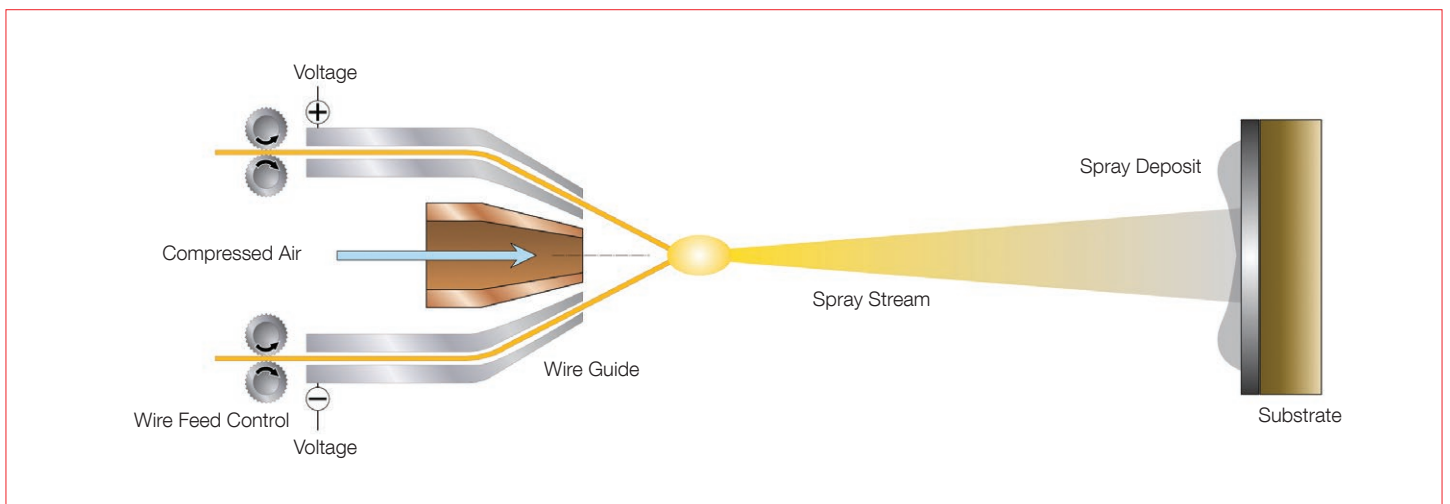

# Key elements of an Electric Arc Wire Solution

## Building blocks of a successful combustion wire spray solution

### Core components

Core elements are required for all electric arc spray solutions. These include the coating material to be applied, a wire drive system, the electric arc wire spray gun that melts the coating material and propels it to the workpiece, a control system that accurately controls the electrical power, air pressure and wire speed requirements, and a power supply to convert incoming AC power to the appropriate DC power required by the spray gun and the coating process.

### Handling components

While many electric arc wire applications employ manual spray gun manipulation very successfully, automated

applications use sophisticated handling equipment that precisely controls the movement of the spray gun and workpiece, and their relative position to one another.

### Peripheral and auxiliary components

A soundproof cabin as well as an air filtration and exhaust system protect booth personnel and the environment. Clean, compressed air is required to propel the molten coating material from the spray gun to the workpiece, and to shape the spray plume for maximum efficiency. For the most advanced process control, spray plume monitoring and diagnostics are recommended.

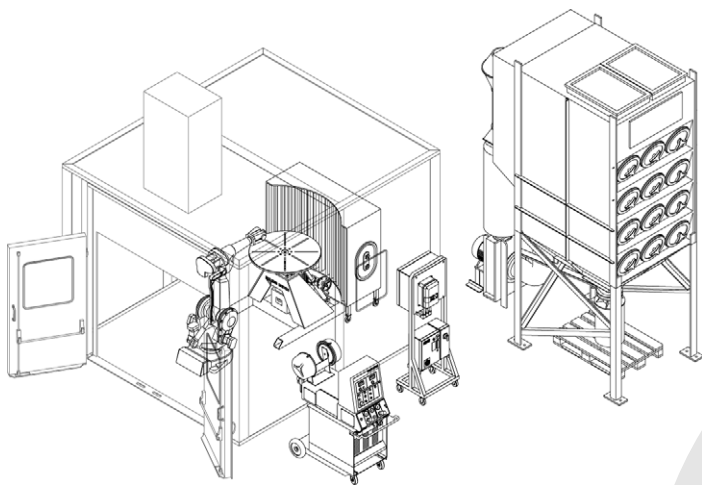

Fully Automated Electric Arc Wire System

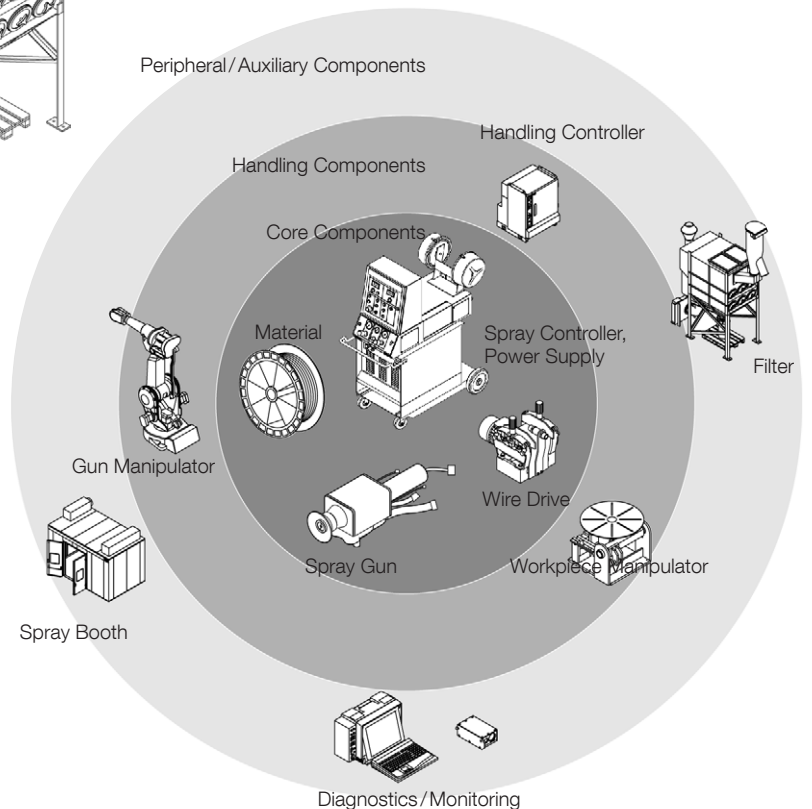

# Materials

Every successful application starts with the right material choice

Oerlikon Metco offers an extraordinarily diverse portfolio of materials for the electric arc wire spray process, each capable of achieving one or more surface functions. Our material engineering, sourcing and manufacturing expertise is unequalled in the thermal spray industry.

Let our specialists work with you to choose the ideal material for your application. The selection of wires we offer for the electric arc wire process includes:

- Pure metals
- Alloys and superalloys
- Cored and composited wires that alloy during the spray process
- Wear resistant carbide materials

To further accommodate specific customer requirements and equipment, many of our wire materials come in several wire diameters. Many of our corrosion wires have multiple packaging options, such as spools, reels or high volume drums, to best suit the application.

Product	Base Form	Application																
		Corrosion/Galvanic Protection	Erosion/Wear/Cavitation Control	Oxidation Resistance	Bio-Fouling Control	Bond Coat	Dimensional Restoration/Repair	Clearance Control	Surface Profiles and Textures	Net Shapes/Dimensional Build up	Chemically Strippable	Decorative/Cosmetic Marketing	Optical/Reflective	Electrical/Thermal Conductance	RFI/EMI Shielding	Gripper/Anti-Skid	Low Friction	Solderable
Metco Aluminum	Al	●	●	●			●				●	●	●	●				●
Metco AlMg	Al	●	●															
Metco SF Aluminum	Al	●					●			●		●						
Metco 8234	Al	●					●			●		●						
Metco 8100	Co	○		●														
Metco Copper	Cu	●	●		●		●				●	●	●					●
Sprabronze AB	Cu	●	●				●		●			●					●	
Sprabronze AA	Cu	●	●				●					●					●	
Sprabronze S	Cu	●	●	●								●	●				●	●
Metco Brass	Cu	●	●									●	●					●
Metco 8235	Fe	○		●												●		
Metco 8237	Fe	○		●													●	
Metcoloy 2	Fe	●		●			●						●		●			
Metcoloy 4	Fe	●	●				●											
Metco 8238	Fe	○		●														
Metcoloy 5	Fe	●	●	●			●											
Metco 8236	Fe	●	●		●													
Metco 8295	Fe	○	●	●														
Metco 8222	Fe	○	●	●			●											
Sprasteel 80	Fe	●		●			●											
Metco 8230	Fe	○		●														
Sprasteel 11	Fe	●					●											
Metco 8223	Fe	○		●														●

● Solid wire ○ Composite/cored wire

**Why should you source your electric arc wires from Oerlikon Metco? The reasons are notable:**

- Our diverse portfolio of products: we can help you choose and supply the material you need.
- Our quality and quality systems are certified to ISO 9001, ISO 14001:1996, Nadcap, and by many of our major customers, as your assurance of the best possible material quality available.
- Our tightly controlled internal specifications means the materials we supply to you are of the highest reliability with excellent lot-to-lot consistency.
- Our in-house expertise, combined with our long, history of successful electric arc spray solutions.
- Our worldwide network of sales offices and hand-picked distributors, backed by our state-of-the-art logistics means we can supply to your company, wherever your location and as fast as possible.
- Secure sources of supply and strong, long-standing supplier relationships ensure material availability.

Product	Base Form	Application																
		Corrosion/Galvanic Protection	Erosion/Wear/Cavitation Control	Oxidation Resistance	Bio-Fouling Control	Bond Coat	Dimensional Restoration/Repair	Clearance Control	Surface Profiles and Textures	Net Shapes/Dimensional Build up	Chemically Strippable	Decorative/Cosmetic Marketing	Optical/Reflective	Electrical/Thermal Conductance	RFI/EMI Shielding	Gripper/Anti-Skid	Low Friction	Solderable
Metco X28	Fe	●	●	●						●								
Metco X10	Fe	●	●							●								
Metco 8297	Fe	○	●	●														
Metco Nickel	Ni	●	●	●						●							●	
Metco 8400	Ni	●		●		●												
Metco 8401	Ni	●		●		●												
Metco 8447	Ni	○		●						●								
Metco 8443	Ni	○	●	●		●				●							●	
Metco 8450	Ni	●	●	●	●	●											●	
Metco 8500	Ni	●	●	●	●													
Metco 8625	Ni	●	●	●	●	●				●								
Metco 8452	Ni	○	●	●														
Metco NiCu (Monel)	Ni	●	●							●								
Metco 470 AW	Ni	●				●				●								
Metco 8276	Ni	○	●	●						●								
Metco 8448	Ni	●				●				●								
Metco Silver	Ag	●											●					●
Metco Silverloy	Ag	●							●				●					●
Metco Tin	Sn	●	●										●					●
Sprababbitt A	Sn	●															●	
WokaDur NiE-Tube	WC	○		●														
Metco Zinc	Zn	●	●							●			●	●				●
Metco ZnAl	Zn	●	●										●	●				●

● Solid wire ○ Composite/cored wire

# Spray units

Ensure the success of your application with the right system

## All purpose Electric Arc Spray units

### FLEXI ARC™ 200

General purpose spray unit with good output rates for the application of coatings for corrosion control, wear protection, lubricious surfaces on bearing seats, etc. Ideal for manual spray operations.

- Output Amperage: 200 A
- Spray Gun: Handheld LD/U2
- Wire Drive: Pneumatic Pull System
- Spool Holder/Decoiler: Included
- Wheels: Included
- Wire Types: All solid electric arc wires



### FLEXI ARC™ 300

General purpose spray unit for application of standard coatings for corrosion control, wear protection, lubricious surfaces on bearing seats, and bond coats for paints and other coatings with high output rates. Ideal for manual spray operations.

- Output Amperage: 300 A
- Spray Gun: Handheld LD/U2
- Wire Drive: Pneumatic Push/Pull System
- Spool Holder/Decoiler: Included
- Wheels: Included
- Wire Types: All electric arc wires





## All purpose Electric Arc Spray units

### SmartArc™

Fully-featured spray unit designed to apply all electric arc coatings with excellent precision, repeatability and reliability. Ideal for aerospace coating applications, including the application of cored wires. Machine-mount and handheld spray guns available.

- Output Amperage: 400 A
- Spray Gun: Machine-Mount PPG or Handheld PPG-H
- Wire Drive: Electric Push/Pull System
- Spool Holder/Decoiler: Included
- Wheels: Included
- Wire Types: All electric arc wires



# Spray units

Ensure the success of your application with the right system

## Specialized Electric Arc Spray units – corrosion control applications

### ECO ARC™ 350

Applies corrosion protection coatings on steel, marine and concrete structures with high output rates. Excellent for on-site applications.

- Output Amperage: 350 A
- Spray Gun: Handheld LD/U3 with safety handle
- Wire Drive: Electric/Pneumatic Push/Pull System
- Spool Holder/Decoiler: Spool or drum decoiler optional
- Wheels: Included
- Wire Types: Zn, Zn/Al, Al, and Al/Mg Anti-Corrosion Wires



## Specialized Electric Arc Spray units – electrically conductive and solderable applications

### CAP™ 300

Designed for the application of coatings to electronic components, such as capacitors and varistors, that can be completely integrated into the production process with very high output rates.

- Output Amperage: 300 A
- Spray Gun: Machine-Mount Schub 5
- Wire Drive: Electric Pull/Push System
- Spool Holder/Decoiler: Spool or drum decoiler optional
- Wheels: Included
- Wire Types: Zn, Zn/Al and Sn/Zn Electrically Conductive, Solderable Wires



## Specialized Electric Arc Spray units – tube weld seam applications

### TUBE™ 300

Applies coatings to the seams of welded metal tubing, to control corrosion and enhance appearance. This unit can be completely integrated into the production process with very high output rates.

- Output Power: 300 A
- Spray Gun: Machine-Mount Schub 5
- Wire Drive: Electric Pull/Push System
- Spool Holder/Decoiler: Spool or drum decoiler optional
- Wheels: Included
- Wire Types: Zn, Zn/Al Al, Sn, Cu



# Extension modules

Extend your Electric Arc Spray capability

## Extension modules for LD/U2, LD/U3 and Schub 5 spray guns

### Extension 300

- Length: 300 mm (11.8 in)
- Minimum bore size: 100 mm (3.9 in)
- Spray Angle: 70°

### Extension 500

- Length: 500 mm (11.8 in)
- Minimum bore size: 100 mm (3.9 in)
- Spray Angle: 70°



## Extension modules for SmartArc PPG spray guns

### PPGT 190 and PPGT 290

- Length:
  - PPGT 190: 330 mm (13 in)
  - PPGT 290: 660 mm (26 in)
- Minimum bore size: 70 mm (2.75 in)
- Spray Angle: 90°

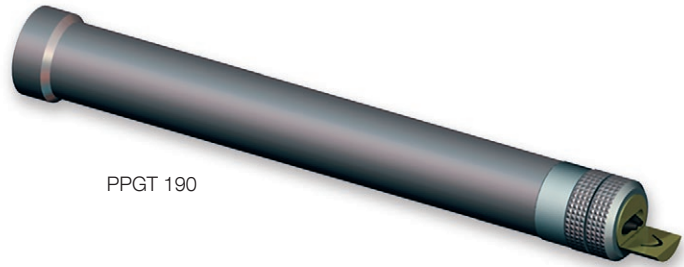

Please note that manual spray is not recommended with extension modules and handheld guns should be adapted for machine mount when using an extension module.

# Diagnostics

## The ultimate tool for real-time spray process control

Continuous, real-time plume monitoring and diagnostics brings a level of process control only dreamed about just a few years ago. This new technology offers key advantages through monitoring of the spray process to within a precise, predefined window of output plume characteristics.

What's more, development time of new spray parameters is significantly reduced using spray plume monitoring and diagnostics because particle and plume characteristics are measurable,

enhancing spray parameter process mapping.

Real-time measurement of:

- Particle velocity and temperature
- Spray plume intensity, position and geometry
- Substrate temperature (optional)

Tecnar Automation Ltd. and Oerlikon Metco combine unrivaled knowledge and experience to bring this exciting new technology to our customers.

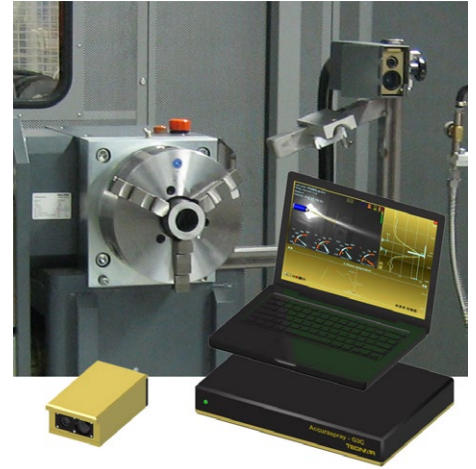

Accuraspray

Accuraspray Camera

# Environment

## Safety and the environment are core Oerlikon Metco values

Safety and environmental control are not simple tasks, but we believe they are the most important aspects of any thermal spray solution. The design of our components and systems meet or exceed the latest codes and standards, and our material SDS (Safety Data Sheets) are written to the latest requirements of each locale.

As part of a Oerlikon Metco coating solution, we consult with you on all the necessary aspects of safety and environmental control to meet your local regulations. This includes air quality and noise control, as well as operator and plant safety.

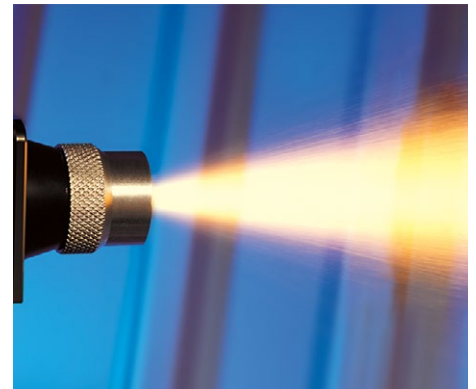

# Solutions

## Intelligent solutions... Expertly designed

Whether you process a wide range of part sizes and shapes with a variety of coatings or require a dedicated coating solution integrated into your manufacturing line, our team is ready to work with your team. Our experienced and knowledgeable professionals are there for every phase of your coating solution, including initial consultation, proof of concept, system engineering and integration, installation and commissioning of a fully functional solution. And we don't just stop there – Oerlikon Metco is always there with after sales support and service.

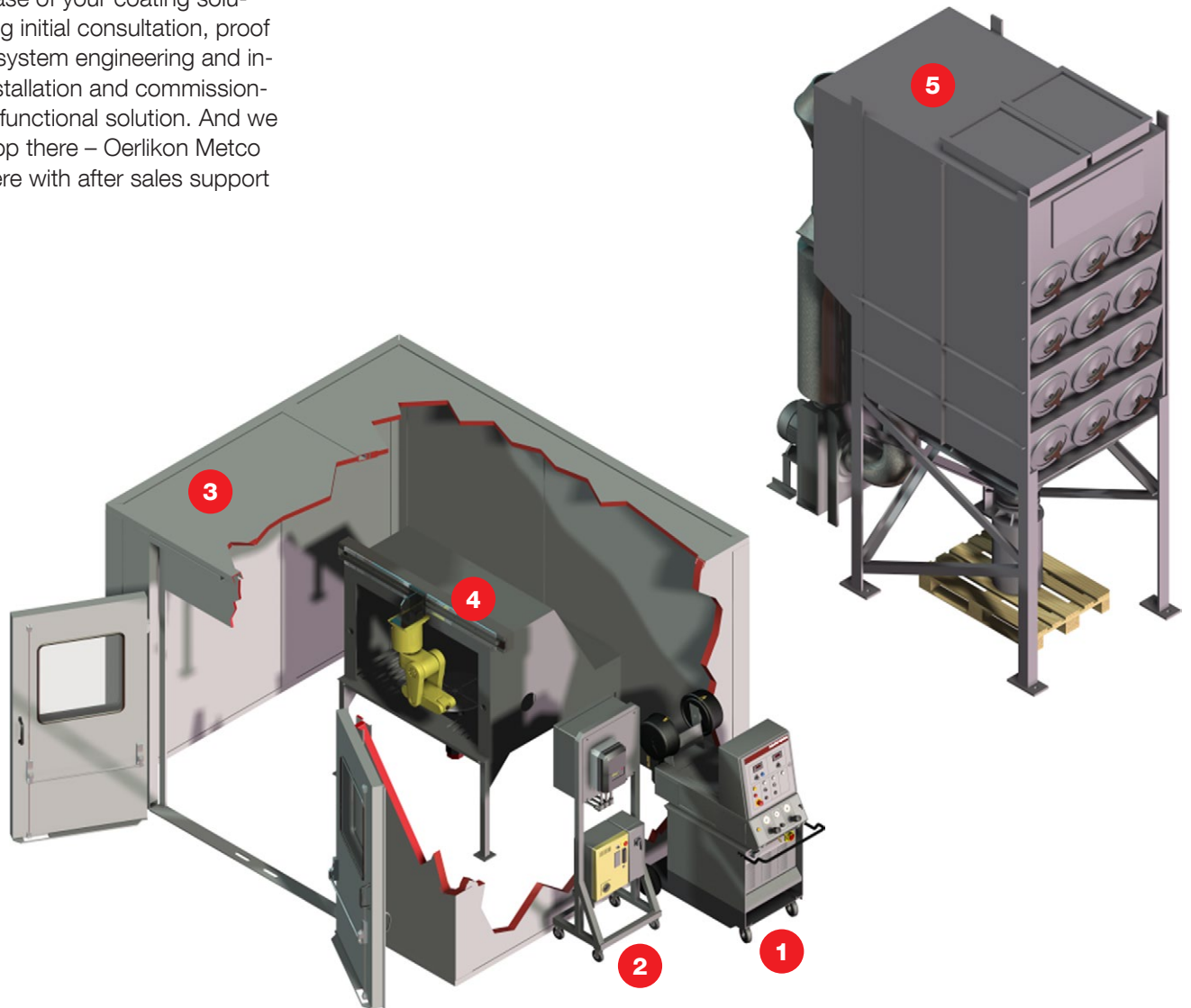

- 1 Smart Arc Controller
- 2 Handling Interface
- 3 Spray Booth
- 4 Handling with Robotic Gun Manipulator and Workpiece Manipulator
- 5 Filter System

# Services

## Oerlikon Metco essential services for on-going success



### Training

Let our staff professionally train your personnel on the safe operation and maintenance of your thermal spray systems. Our training solutions range from the basics of thermal spray through expert knowledge on safety, maintenance and spray practices.



### Field service

Qualified, factory-trained field service technicians will keep your systems in peak operating condition. Our field services include flexible maintenance contracts, emergency break-down repairs and troubleshooting help.



### Traceability

Fully traceable calibrations ensure the accuracy and repeatability of your spray facilities.



### Application consultation services

Our thermal spray professionals can consult with you for a total application solution with optimized benefits and value. Whether your needs are for a new surface solution, or an improvement to your existing application, our experts are at your service.

### Consumable and spare parts support

Oerlikon Metco brand consumable and spare parts keep your coating facilities operating with repeatable results.

### Simplified sourcing

Simplify your purchasing decisions with Oerlikon Metco quality consumable parts and materials from a single source that can supply all of your electric arc spray needs.

### Global sales and logistics

Oerlikon Metco professionals are prepared to help, wherever your location.

# Combustion wire spray

## Advanced technology solutions and services



**Electric  
Arc**

### Perfect solutions through optimum materials and innovative technologies

Oerlikon Metco is a global leader in surface engineering solutions and services offering:

- A broad range of thermal spray and other advanced surface technology equipment
- Integrated systems and materials
- Specialized coating and surface enhancement services
- Customer support services

Oerlikon Metco provides a comprehensive manufacturing, distribution and service network, catering to aviation, power generation, automotive and other strategic growth industries.

To take control of your surface engineering challenges, contact your Oerlikon Metco sales office, visit our web site at [www.oerlikon.com/metco](http://www.oerlikon.com/metco) or e-mail us at [info.metco@oerlikon.com](mailto:info.metco@oerlikon.com).

### About Oerlikon Surface Solutions Division

Oerlikon is a leading global provider of surface and additive manufacturing solutions and services. The division offers an extensive portfolio of market-leading thin-film, thermal spray and additive manufacturing technologies, equipment, components and materials. Emission reduction in transportation, maximized longevity and performance of tools and components, increased efficiency and intelligent materials are hallmarks of its leadership. Pioneering technology for decades, the division serves customers with standardized and customized solutions across a worldwide network of more than 170 sites in 37 countries. With its technology brands – Oerlikon Balzers, Oerlikon Metco and Oerlikon AM – Oerlikon's Surface Solutions division focuses on technologies and services that improve and maximize performance, function, design, reliability and sustainability, which are innovative, game-changing advantages for customers in the automotive, aviation, tooling, general industries, luxury, medical, semiconductors, power generation and oil & gas markets. The division is part of the publicly listed Oerlikon Group, headquartered in Switzerland, which has 12 000 employees and generated CHF 2.65 billion in revenue in 2021.

Information is subject to change without prior notice.