

S+

Getting the Maximum
out of Three Ends

S+

Getting the Maximum out of Three Ends!





For more than 15 years now, Oerlikon Neumag has been supplying plants with three ends per position. Today, our three-end plant technology is worldwide the most accepted and the S+ is the best BCF three-end plant which we have ever manufactured.

The S+ builds on components which have for years been tested and proven and have been further developed and optimised. Therefore the S+ not only guarantees highest performance, but also reliability from the first minute onwards.

A nearly straight yarn path in the spinning system, further developed from the single-end Sytec One, combined with the high efficiency of a three-end technology at the take-up machine, together, results in a BCF plant which sets new standards.

S+

Top Performance and Ergonomical Design



Key Benefits



Higher Production Speeds and Capacity

Up to 25 % productivity increase per position compared to the S5

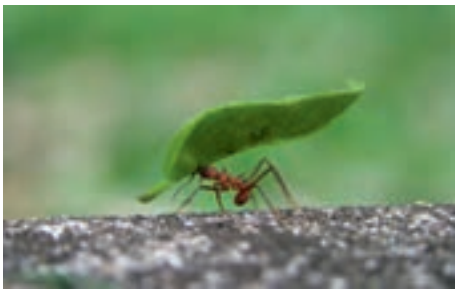

99 % Efficiency

Efficiency increase from 98 % to 99 % (monocolour) thus producing more high quality yarn and less waste



Outstanding cost / performance ratio

Best cost / performance ratio of all Neumag BCF technologies with regard to investment and production



E-Save Certified

Lower energy consumption compared to all other BCF technologies available in the market today

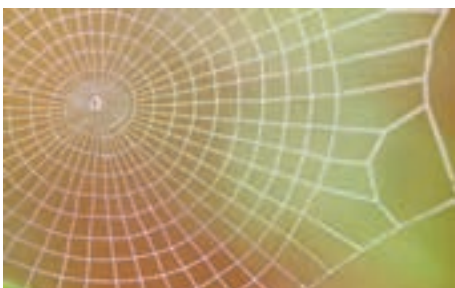

Best Quality of Produced Yarn

Outstanding yarn quality with best heat-set performance and evenness in the carpet

Design Features

Spinning



Dosing and extruding the polymer with leading technology

Approved Metering Units

The gravimetric system is equipped with one main component and two hoppers for additives such as masterbatch or UV stabilizer (upon request also with additional hoppers).

We offer Doteco as a standard metering unit which has been proven world-wide for BCF machines for many years.

Energy Efficient Extrusion Systems

Extruders from Oerlikon Barmag are not only well-known for their high reliability but also for the best possible melting process. A special screw design ensures optimal homogenisation of melt and masterbatch. In addition the excellent insulation and the high-quality drives guarantee high energy efficiency.

A wide selection of special screw designs for different polymers and polymer combinations are available to secure maximum performance.

Incorporated Spinning Beam

One new aspect of the S+ is a dow-therm system which is integrated in the spinning beam and heated via flexible heating cartridges.* As a result temperature losses drop to a minimum and extensive assembly works for the boiler and the piping are not necessary.

The spinning beam design ensures a very homogeneous melt distribution and has not been changed. The temperature profile of each plant is adjustable for two positions each.

* Please note that due to country-specific regulations, this system cannot be applied in every country.

Optimised Quench Air and Spinneret Design

The quenching and the spinnerets have been optimised to high-speed processes, ensuring best cooling performance of each single filament. With regard to quantity and speed, the quench air can be individually adjusted per position.

Straight Yarn Path

A straight yarn path is the basis for a stable high-speed process. That is why we have designed the S+ spinning system with a spinning angle of practically zero degrees – even with three ends per position. This guarantees a perfect yarn treatment right from the beginning.

Increased Spinning Heights

The spinning heights have been increased in comparison to the S5. This leads to a more robust process over the entire titer range.

AF+ Spinning Ducts

The new air flow optimised spinning duct design keeps each yarn end separated in its own spinning duct, which completely eliminates filament change-overs. Together with the specially designed air slots, air turbulences are reduced to a minimum.

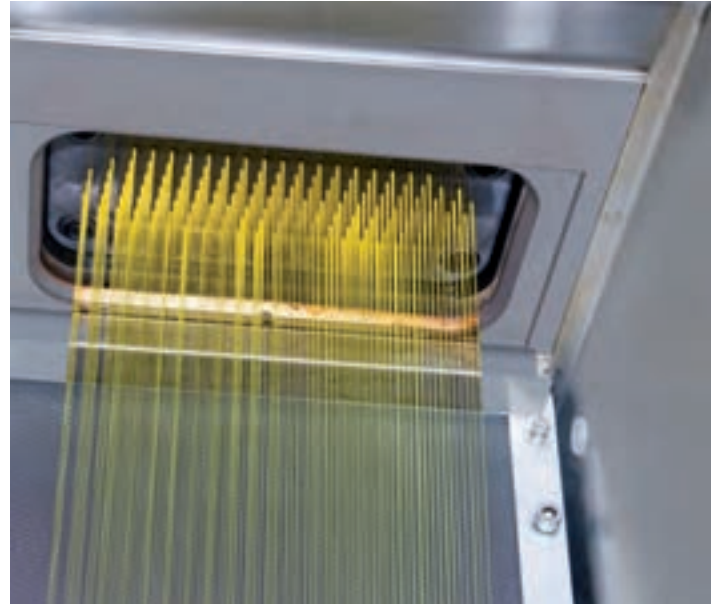

High speed spinning with optimised spinnerets



AF+ New air flow optimised spinning ducts

Design Features

Take-up



Reliable and proven components guarantee long-life operation (PET configuration shown)

S+ Take-Up Unit

The take-up unit is the core of each BCF plant. Although its design has been completely reworked, it is equipped with long proven components which are optimised for the special demands of the S+ processes.

With the S+ the width per position is 2 m for monocolour and 2,2 m for tricolour, the height has been decreased – all this allows a much more comfortable handling.

By using a steel construction for the machine frame, the depth of the plant is reduced and therefore the accessibility from the rear side, for maintenance and repair works, has been significantly improved.

With the S+ it is now possible to produce different yarn qualities on each position. The pressures for the airmover, yarn exhausting, pre-tangling, texturing and tangling are individually adjustable per position (electronically or mechanically) and therefore ensure maximum flexibility.

F-Jet Pre-Tangling and Spin Finish System

The F-Jet is a newly developed system for pre-tangling and applying spin finish. The spin finish application on the yarn has been improved which reduces the spin finish consumption. Excess oil is collected and could, if required, also be recycled. There is no splashing any more so that the plant remains free of spin finish.

Godets from Oerlikon Neumag

The in-house manufactured godet is a key component and the foundation for a long-term, trouble-free operation of the S+.

The six-zone ferrite heating technology of the draw godets provides even surface temperature for uniform yarn shrinkage and optimal heat transfer. It is proven to be highly durable at winder speeds up to 3500 m/min. Due to the plug-in-type electric connections, the godets are easy to install and disassemble.



Six-zone ferrite heated godets for individual heat profiles

Design Features

Take-up



Highest bulk and crimp stability due to optimised texturing and cooling combination (U-groove design shown)

Texturing from Oerlikon Neumag

The original Oerlikon Neumag texturing system for the creation of high bulk and yarn volume ensures excellent carpet coverage.

The plants are standardly equipped with our vacuum texturing system, which is very robust and easy to adjust for a long-term trouble-free operation.

The BiTex texturing, which is available as an option, controls the yarn plug position via rollers providing higher uniformity often needed for sophisticated products like automotive applications. It operates without any vacuum during production.

Advantages of both Oerlikon Neumag texturing systems are a very long life-time, easy cleaning and maintenance. Each single nozzle or lamella can, if necessary, be exchanged.

As an option you can choose Oerlikon Neumag cermet lamellas which have a high bending strength and better hardness compared to ceramic lamellas resulting in increased wear resistance.

Cooling Drum

A cooling drum with a diameter of 480 mm is used for the S+ and ensures an optimal retention time and therefore cooling of the yarn. Moreover, we have different plaiting profiles for the polymers PP, PA and PET. Thus guaranteeing a polymer specific optimal setting of the crimp.

Intermingling

The S+ is equipped with a Temco Tandem Tangling ensuring a high number of knots and uniformity also at high speeds.

With certain masterbatches, very high dust pollution can contaminate the tangling area. For this reason, we have improved the exhausting and optimised the air flow. The dust pollution remains low even with critical masterbatches. Furthermore we have reduced the noise level in the tangling area.

Winder

The most significant innovations of the winder series are protected in over 30 international patents. During the development of the Witras winder, the numerous customer requirements for a reliable and advanced winder were incorporated.

For the S+, we have further developed our well proven wing traversing winder. The new Witras 3003 RS+ has no belt for driving the single wings. Instead one drive has been installed for each pair of wings.

During bobbin change, the yarn is led to the bobbin holder with a re-designed mechanism which further improves catching reliability and eliminates friction of the yarn on the paper tube. The inverters are now installed in the air-conditioned central switch cabinet room which protects the equipment better against heat, air-borne contaminants or spin finish.



Tandem tangling for most uniform tangling results combined with a significantly improved dust exhaust system



A new kind of winding – single drive on each pair of wings with a re-designed mechanism (max. winding speed of 3500 m/min)

Multicolour Production

Tricolour Production with a three position spinning beam and three ends

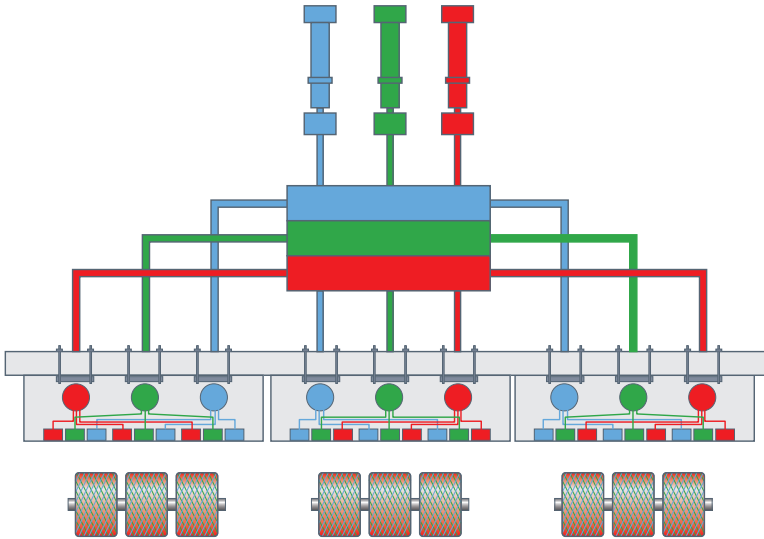

Monocolour production of three different colours with a three position spinning beam and three ends

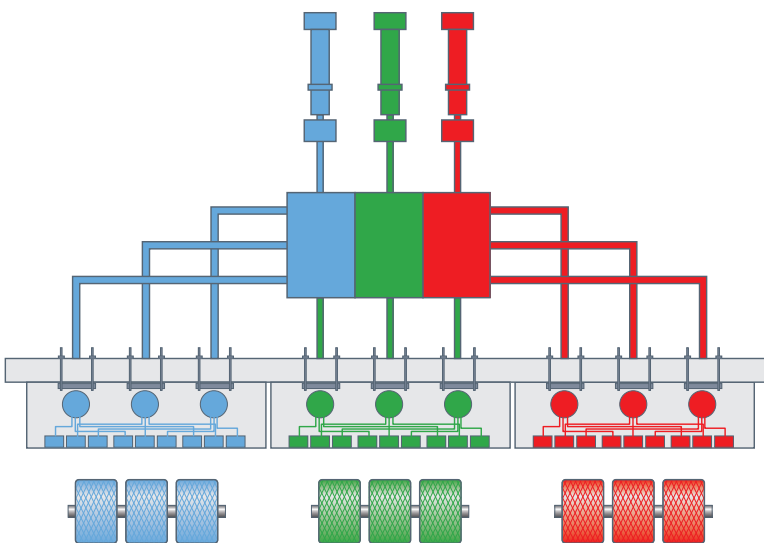

Variomelt for Tricolour Production

Variomelt is a tricolour BCF plant equipped with a melt flow changing device. It offers the flexibility of producing tricolour or three different coloured monocolour BCF yarn products.

The Variomelt system is integrated in the spinning beam. With Variomelt the plant can be converted from tricolour to monocolour mode. The close connection of the extruders to the spinning beam guarantees the shortest possible product lines and the lowest possible flushing losses during product change. In combination with one extruder per position, it is attractive for small lots of monocolour yarns because the running times of the lots are increased, therefore the flushing losses during colour change are reduced by 2/3rds.

Cam Rolls for Tricolour Production

The cam roll is located in the infeed section of the machine, between the F-Jet and inlet godets.

The cam roll is used in a three-colour machine to mix the 3 different yarn ends with each other. The frequency of the mixing is adjustable while the cam roll motor speed can be changed. The cam roll ensures a very even mixing effect for a uniform looking carpet where the colours do change in a certain pattern. It is an important parameter for the even appearance of your carpet.

Colour Pop Compacting for Tricolour Production

CPC – Colour Pop Compacting – is a new method for separating colours in a multicolour BCF process that raises the level of colour separation, increases flexibility and reduces total investment and operating costs for these products.

If different degrees of colour separation are needed, only the operating pressure of the CPC unit has to be adjusted. The higher the set pressure (range approximately 2 – 8 bar), the more distinct is the colour separation (colour pop).

The colours run over the godet separately, are individually intermingled (tangled) in the CPC unit and then run into a texturing nozzle. Therefore, it is possible to use a standard texturing head.



Get the maximum of flexibility out of three colours with CPC

Electrical Equipment

We use the latest generation of electrical equipment from our system supplier Siemens. We thus reduce interfaces and also ensure the reliable supply of original parts for the entire life cycle of the plant.

Process Control System

The process control system is designed for the collection and management of data from the entire system. The process control system displays the set points and actual values as well as the state and malfunctions.

The synthesis from an individual programming with the display of the Oerlikon Neumag process know-how and widespread base software with open database, results in maximum user-friendliness, flexibility and expandability. Examples are the integration of different components on one operator interface including the integration of a considerable amount of external hardware, the possible data exchange with other software programs (for example MS-Excel) as well as the display of specific customer requests which can be realised upon individual agreement (optional).

Plant Operation Center

POC– Plant Operation Center – is the all-embracing workflow management system by Oerlikon Textile. It is designed to detect and optimise the production processes within a production stage, e.g. spinning and texturing, or over all production stages – starting with the raw material up to the end product.

- Modular Concept
- POC User Management
- POC Shift Management
- POC Recipe Management
- POC Reports
- POC Plant Overview
- POC Alarm Management

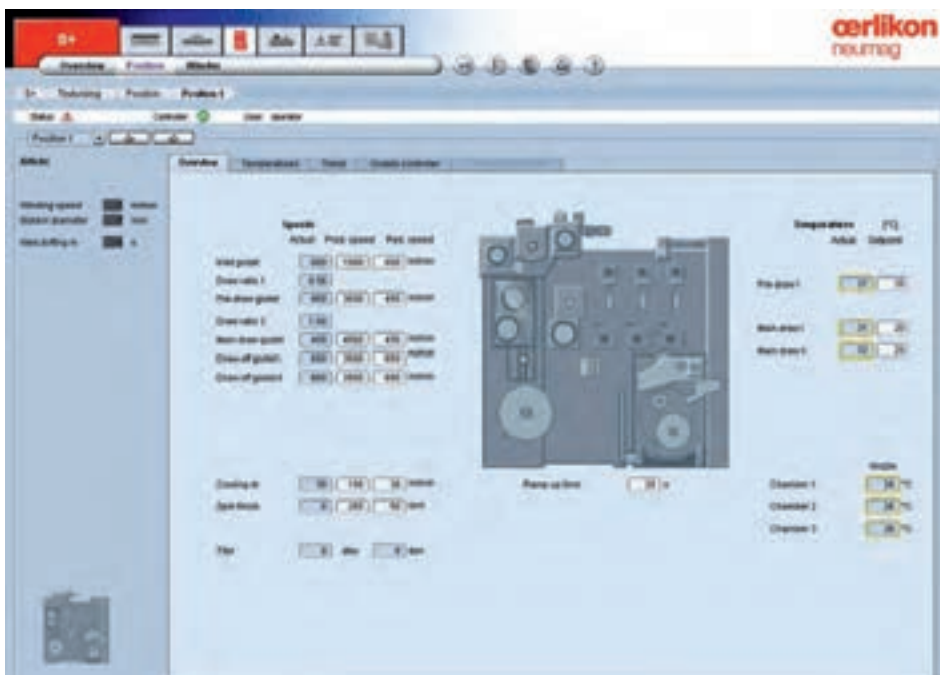

Perfect plant controlling with Oerlikon Neumag's PCS

Machine Design

The machine is better accessible from the front and the rear side. Thanks to the increased width, operating the machine became much easier. The depth of the machine has been

reduced by using a welded steel frame instead of an iron cast. This means easy access to the machine from the rear side for maintenance.

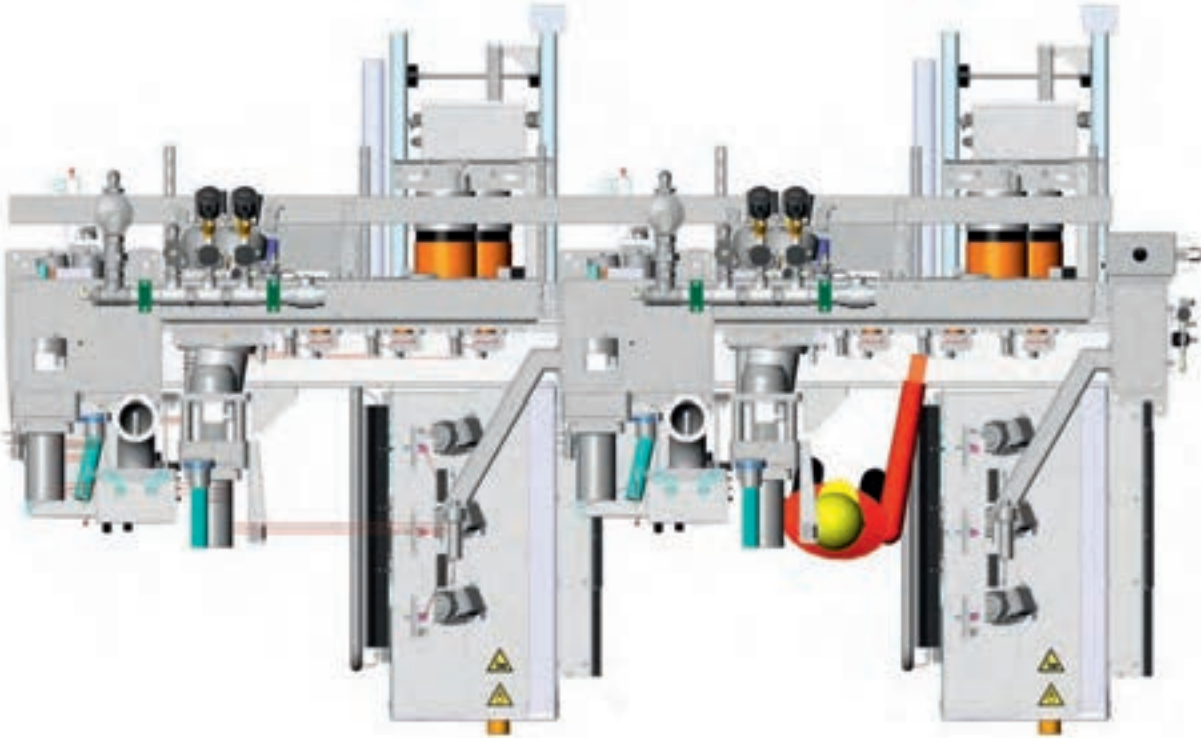

Top View

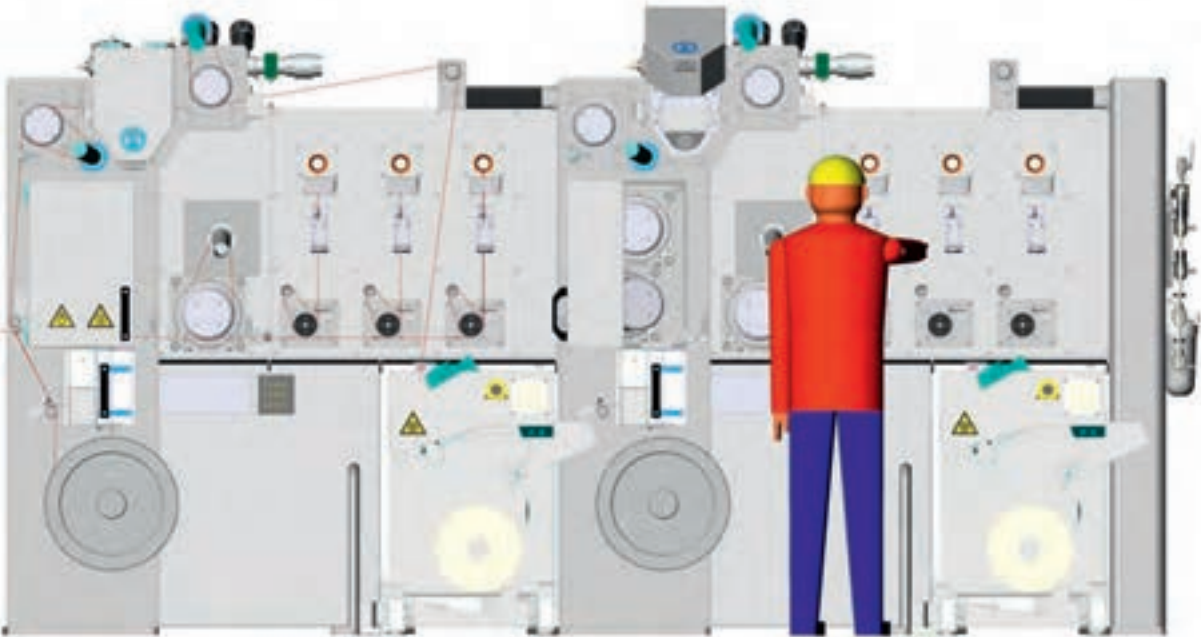

Front View

Plant Layout Examples

2x2 Positions S+ PP Monocolour

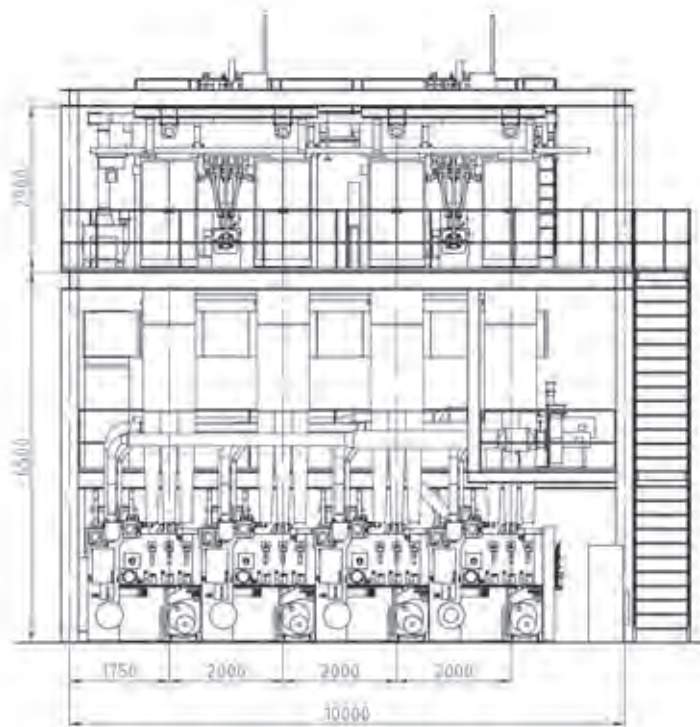

Front View

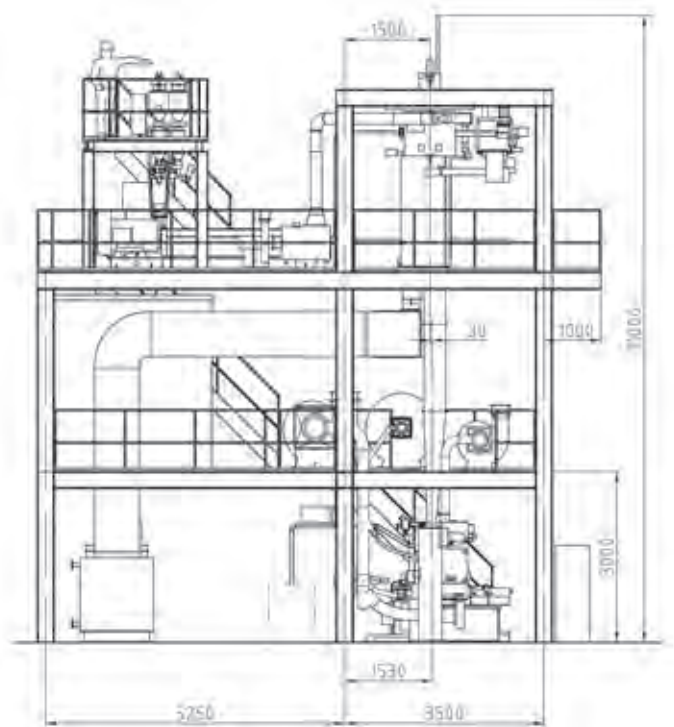

Side View



Typical plant design setup

1x4 Positions S+ PET Monocolour

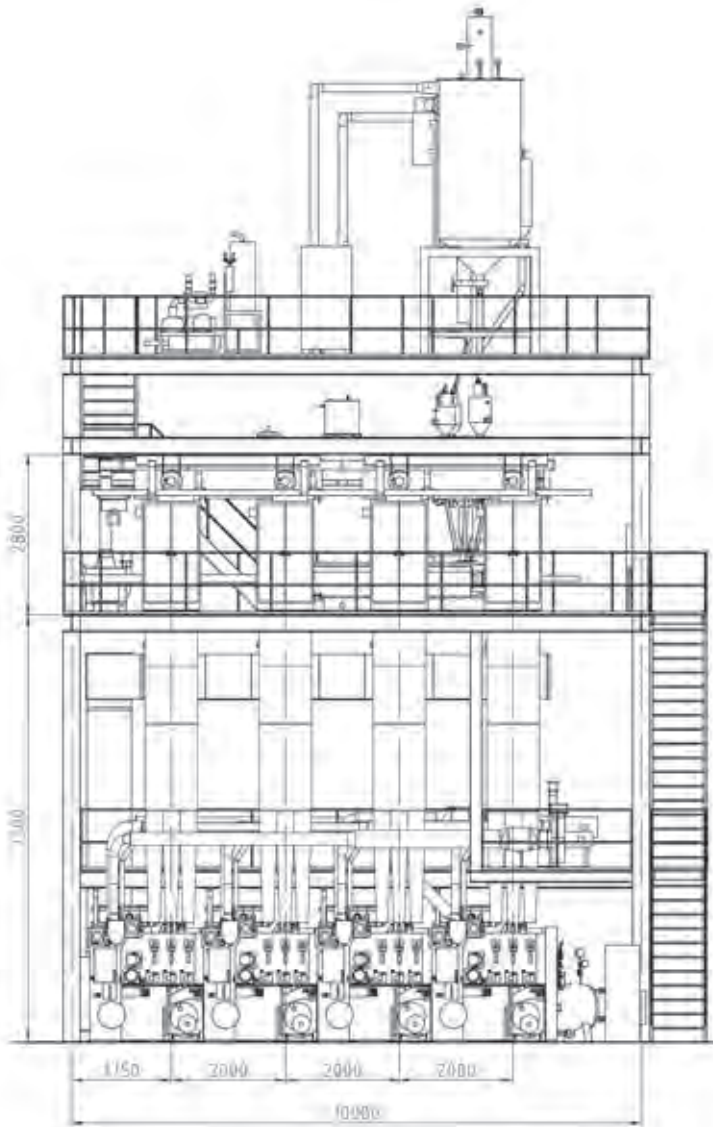

Front View

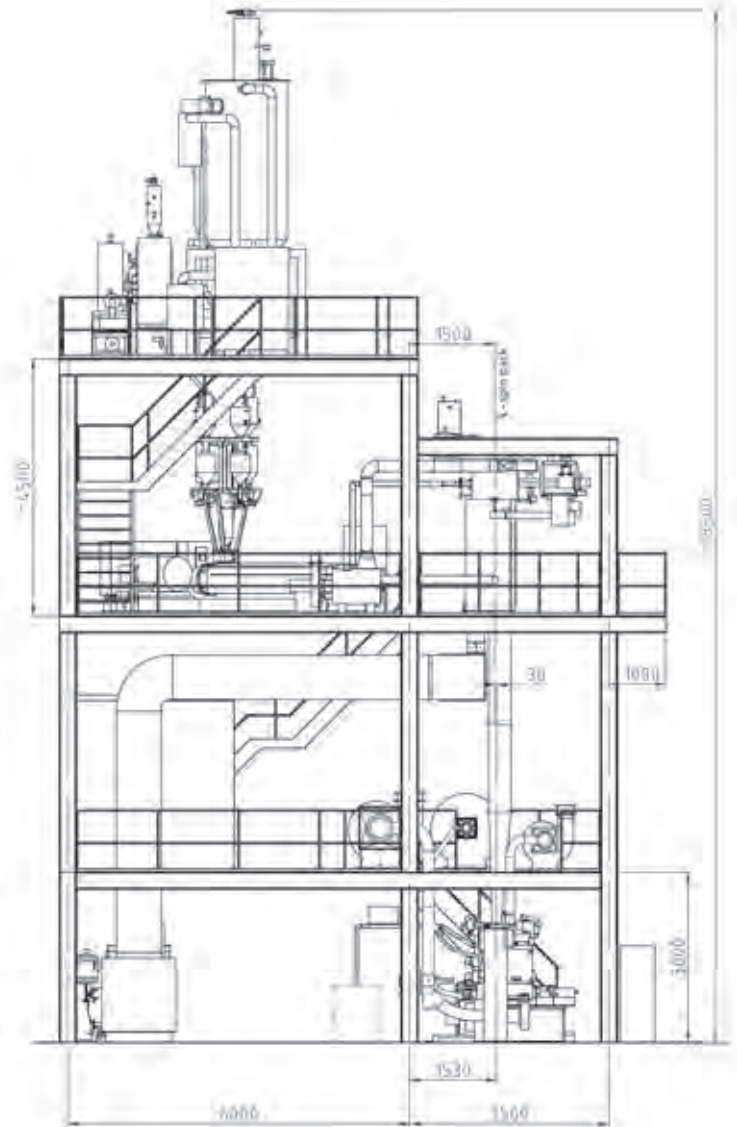

Side View

Machine Configurations

Monocolour Positions for PP, PA6, PET

1x2

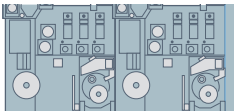

2x2

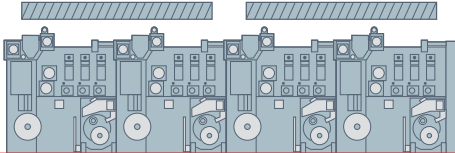

3x2

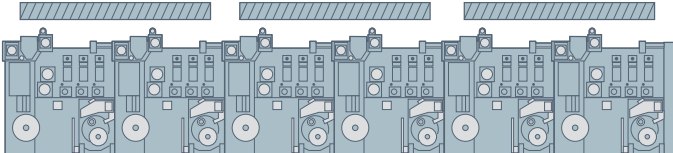

1x4

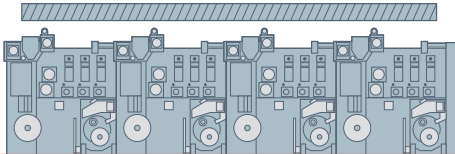

2+4

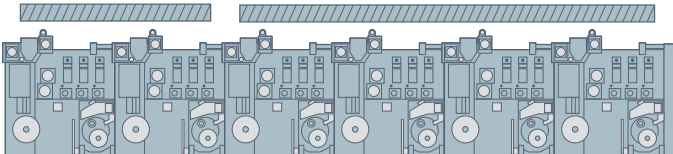

Tricolour Positions for PP, PA6, PET

1x3

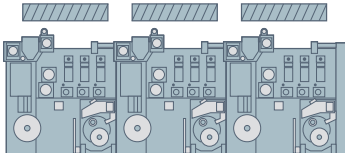

2x3

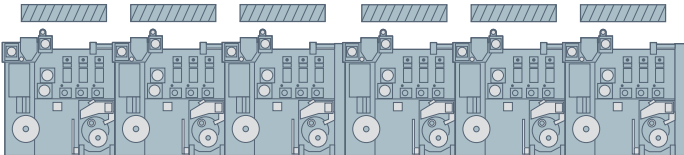

Additional Monocolour PET Positions

1x6

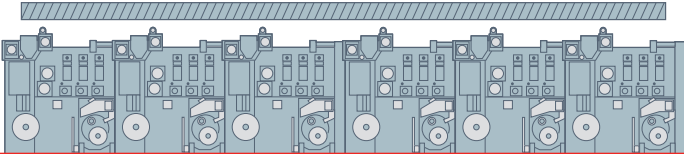

2x4

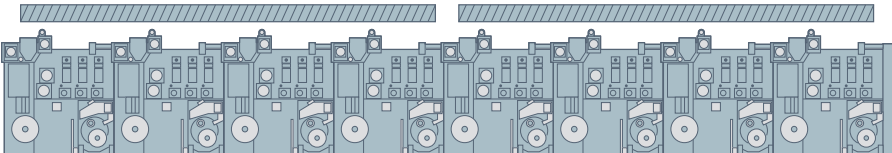

Combination Lines

Possible Polymer combinations

Polymer Possibilities						
S+ Plant Type	PP	PA 6	PET (IV 0,64-0,69)	PET (IV 0,75-0,84)	PTT / 3GT	R-PET
PP Plants	yes	yes with PA 6 Upgrade (Pre-Installation oder Conversion)	no	no	no	no
PA6 Plants	yes with PP Upgrade	yes	no	no	no	no
PET Plants Fiber Grade Design	yes with PP Upgrade	yes with PA 6 Upgrade	yes	no	no	no
PET Plants Bottle Grade Design	no	yes with PA 6 Upgrade	yes	yes	yes	yes

Polymer conversions or additional polymer capabilities require additional and/or modified equipment

Technical Data

	S+
Polymer	PP, PA6, PET
Monocolour	yes
Tricolour	yes
No. of positions	Mono 2, 4, 6 Tri 3, 6
Ends per position	3
Efficiency	99 % monocolour, 98 % tricolour
Max. no. of filaments monocolour	360
Max. no. of filaments tricolour	300
Titer range monocolour ¹	700 – 4000
Titer range tricolour ¹	1000 – 4000
Dosing system	gravimetric
Dpf range ¹	5 - 40 dpf
Dowtherm heating	incorporated into spinning beam
Spinneret design monocolour	rectangular
Spinneret design tricolour	round
Capillary cross-section	trilobal ² , delta, hollow
Pre interlace unit	F-JET
Cam roll for tricolour	option
CPC for tricolour	option for PP and PET (max. 2700 dtex)
Variomelt	option
No. of heated godets	3 (PP) / 3 or 4 (PA6) / 3 SIG ³ + 4 Main (PET)
Heating zones main godets	6
Heating principle of the main godets	induction
Lubrication system of the heated godets	oil mist
Texturing system	Friction ² , BiTex
Texturing nozzles	LD, MD, HD
Lamella chamber	S, M, L
Cooling drum diameter	480 mm
Cooling drum cross-section	U-groove for PP, V-groove for PA and PET
Intermingling unit	Temco Tandem
Min winder speed	1800 m/min
Max winder speed	3500 m/min
Max bobbin diameter	320 mm
Pitch	monocolour 2000 mm tricolour 2200 mm
Spinning height	PP 6,5 m, PA 7,5 m PET 6,5 - 7,5 m

¹ the possible titer range depends on the polymer and the no. of filaments

² standard

³ Single Infeed Godet

Production Data PP

Titer [dtex]	Winder speed [m/min]	Capacity per end [kg/h]
3000	2600	47
2900	2640	46
2600	2880	45
2400	3000	43,2
2300	3000	41,4
2100	3000	37,8
2000	3000	36
1850	3000	33,3
1700	3000	30,6
1600	3000	28,8
1400	3000	25,2
1100	3000	19,8

Production Data PET

Titer [dtex]	Winder speed [m/min]	Capacity per end [kg/h]
4000	1800	43,2
3600 ^{a)}	2000	43,2
3300 ^{a)}	2100	41,6
3000 ^{a)}	2300	41,4
2900 ^{a)}	2380	41,4
2600 ^{a)}	2650	41,3
2400 ^{a)}	2850	41,0
2100 ^{a)}	3200	40,3
2000 ^{a)}	3200	38,4
1700 ^{a)}	3200	32,6
1400 ^{a)}	3200	26,9
1100 ^{a)}	3200	21,1
900	3200	17,3
800	3200	15,4
600	3200	11,5

^{a)} tricolor

Production data refer to an IV of min. 0,75 (solid stated, bottle grade qualities)

Production data for IV of 0,64 - 0,69 are reduced by 10 %

PA production data

40 filaments

e.g. 1000 f 40 for automotive solution-dyed applications

Titer [dtex]	Winder speed [m/min]	Capacity per end [kg/h]
900	3000	16,2
1000	2880	17,2
1300	2300	17,8
1500	2130	19,2
1600	2050	19,7

PA production data

68 filaments

e.g. 1300 f 68 for contract and residential applications

Titer [dtex]	Winder speed [m/min]	Capacity per end [kg/h]
900	3200	17,2
1000	3200	19,2
1300	3190	24,8
1500	3030	27,2
1800	2730	29,3
1800	2730	29,3
2000	2510	30
2300	2260	31,2
2500	2160	32,3
2700	2070	33,5

PA production data

150 filaments

e.g. 1660 f 150 for residential and automotive solution-dyed applications

Titer [dtex]	Winder speed [m/min]	Capacity per end [kg/h]
1500	3200	28,7
1660	3200	31,8
1700	3200	32,5
1800	3200	34,5
1800	3200	34,5
2000	2970	35,5
2400	2600	37,3
2800	2310	38,7
3300	2010	39,7



Oerlikon Neumag

Zweigniederlassung der
Oerlikon Textile GmbH & Co. KG
Christianstraße 168-170
D-24536 Neumünster
Phone +49 4321 305-353
Fax +49 4321 305-212
sales.neumag@oerlikon.com

www.neumag.oerlikontextile.com